

80

IGE series

80X80X38mm

●General Specification / 一般規格

- Motor /Inner rotor, shaded pole AC motor
- Material/Frame:Al alloy
- Impeller:PBT plastic
- Insulation/Class'B'or'F'
- Connection/Lead wires;Terminal
- Weight / 340g
- 馬達/內轉子蔽極啟動
- 材質/框:鋁合金;葉:塑膠
- 絕緣等級/B或F
- 連接/導線
- 連接/導線;端子
- 重量 / 340克



●Specification / 詳細規格 *軸承/bearing B:雙滾珠/ball bearing F:FMB S:含油承軸/sleeve bearing

Model	Motor Type	Bearing	Voltage	Frequency	Watt	Speed	Max Air Flow		Max Static Pressure		Noise	Weight
机型	马达种类	轴承	电压	频率	功率	转速	最大风量		最大风压		噪音	重量
Part NO.	○/◎	B/S	V	Hz	W	RPM	m³/min	CFM	mm-H ₂ O	in-H ₂ O	DBA	g
IGE08038B1H	◎	B/S	110	50/60	13/10	2400/2900	0.68/0.88	24/31	3.30/4.83	0.13/0.19	31/35	340
IGE08038B2H	◎	B/S	220	50/60	13/10	2400/2900	0.68/0.88	24/31	3.30/4.83	0.13/0.19	31/35	340

● Drawing/ 圖面及出入風口

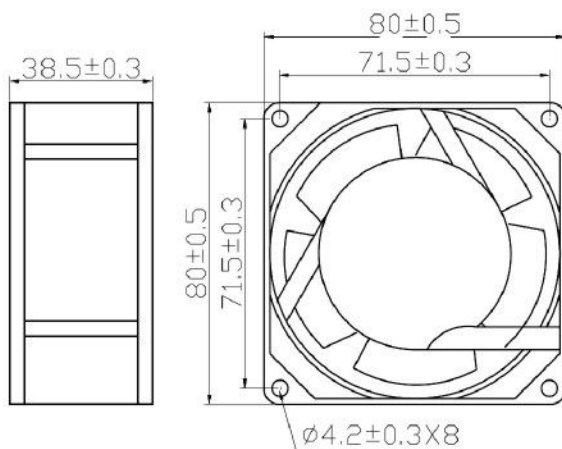

● Characteristic Curves/ 特性曲線

